

660 series

Power toggle switches - metal lever

Specifications

ELECTRICAL SPECIFICATIONS

- Max. current/voltage rating with resistive load : 5A 250VAC - 10A 125VAC - 10A 30VDC
- Decrease by 50 % for inductive load
- Initial contact resistance : 10 mΩ max. at 1A 2VDC
- Insulation resistance : 1.000 MΩ min. at 500VDC
- Dielectric strength :
 - 2.500 Vrms 50 Hz min. between terminals
 - 2.500 Vrms 50 Hz min. between terminals and frame
- Electrical life : 10.000 cycles at full load

MATERIALS

- Case : melamine/polyester
- Actuator : brass, nickel plated
- Bushing : brass, nickel plated
- Contacts : silver

GENERAL SPECIFICATIONS

- Torque : 1,50 Nm (1.10 Ft.lb) max. applied to nut
- Panel thickness : 4,5 mm (.177) max.
- Operating temperature : -20°C to +55°C

PANEL CUT-OUT

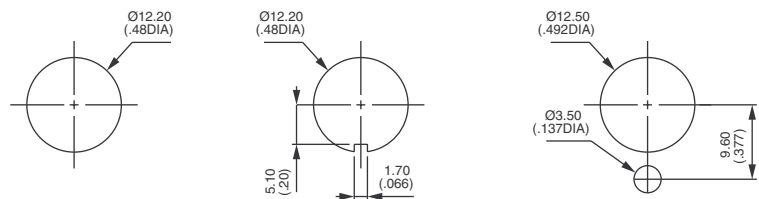

ABOUT THIS SERIES

Dimensions : first dimensions are in mm while inches are shown as bracketed numbers.



Sealing boots are available to protect the switches against dust and water. They are presented in section H.



Mounting accessories : standard hardware supplied with all models : 1 hex nut U166, 1 knurled nut U411 and 1 lockwasher U13
Standard and special hardware are presented in section I.



Packaging unit : 25 pieces per type.

660 series

Power toggle switches - metal lever

Four pole

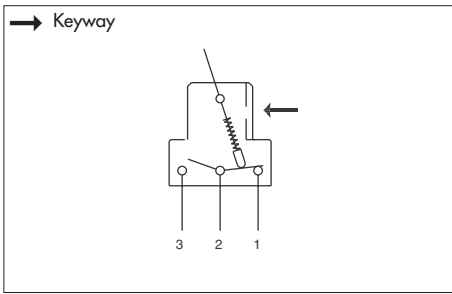

- 2 and 3 maintained or momentary positions
- Screw terminals

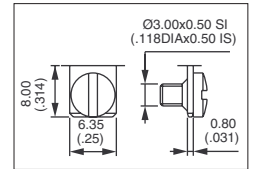

MODEL
STRUCTURE



Four pole



661
665
666
667
668
669

III	II	I
2-1*		2-3**
ON	-	OFF
MOM	-	ON
ON	-	ON
MOM	OFF	MOM
ON	OFF	MOM
ON	OFF	ON

* (2-1) (5-4) (8-7) (11-10) ** (2-3) (5-6) (8-9) (11-12)

→ Keyway

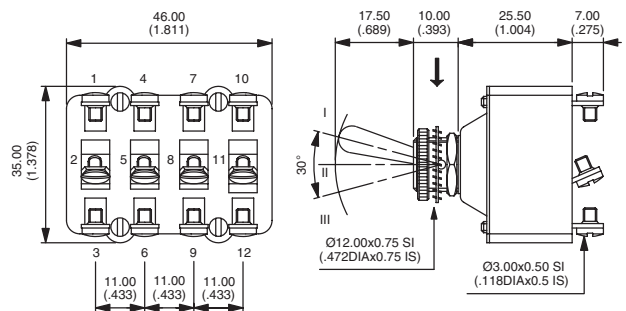

TERMINAL OPTIONS

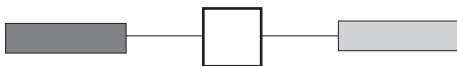

- /2 Solder lug terminals
- /3 Quick-connect terminals 6,35 x 0,8 (.250 x .031)

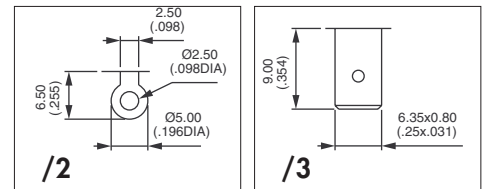

OTHER OPTIONS

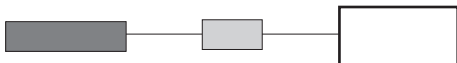

- T Tropicalized diallylphthalate case (-40°C to +85°C)
- LUXE Chrome plated lever and cap nut U117
- TK LUXE Front panel sealing by O-ring and sealing washer + options T and LUXE. See 600H series.
- G Matt black finish on bushing, lever and nuts. Includes tropicalization (option T)
- GK Front panel sealing by O-ring and sealing washer (as described in option TK LUXE) + option G