

New! B SERIES SNAP-IN ROCKER SWITCHES

N

FEATURES

- Cost effective illuminated or non-illuminated models.
- Single pole and double pole maintained action models.
- Actuator and case color selections.
- Standard actuator marking options.

SPECIFICATIONS

Contact ratings:	10A 250VAC (UL/CSA) 15A 125VAC (UL/CSA)
Initial contact resistance:	20 milliohms max.
Insulation resistance:	100 megohms min. at 500 V
Dielectric strength:	1000 VAC for 1 minute
Electrical life:	6000 cycles at full load
Operating temperature range:	-20°C to 85°C

MATERIALS

Contacts:	Copper alloy	Lamps: Neon or fluorescent.
Terminals:	Silver or tin plated copper alloy	
Actuator:	Nylon (UL94V-2 min.)	
Case:	Nylon (UL94V-2 min.)	

AGENCY RECOGNITION



UL & CSA. Models are supplied with agency markings.

Single pole - non-illuminated - quick connect terminals



MODEL NO.	CIRCUIT
B120R2NBB0NN	ON NONE ON
B160R2NBB0NN	ON NONE OFF

Above models have black actuator.

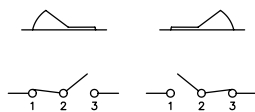

Max. panel thickness: .083 [2.10]

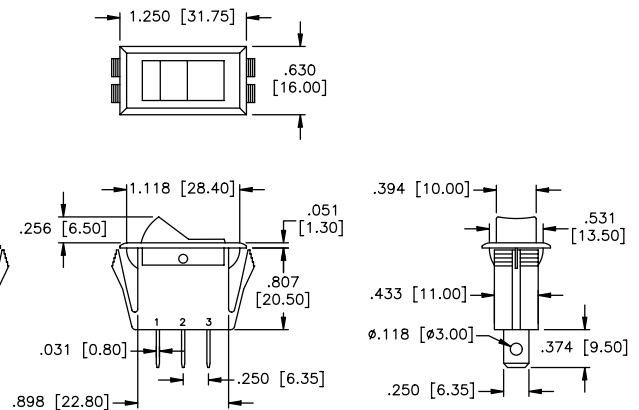

Single pole - illuminated - quick connect terminals



MODEL NO.	CIRCUIT
B120R2LBB1NN	ON NONE ON
B160R2LBB1NN	ON NONE OFF

Above models have black actuator.

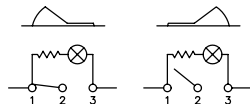

Max. panel thickness: .083 [2.10]

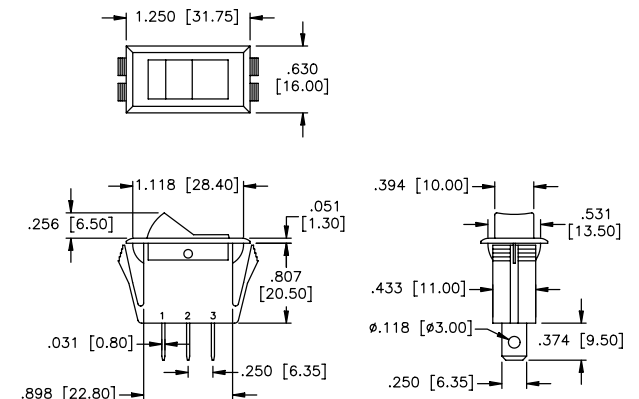

SPECIFICATIONS SUBJECT TO CHANGE WITHOUT NOTICE

New! B SERIES SNAP-IN ROCKER SWITCHES

N

Additional ordering information: Commonly ordered models are shown above with complete model numbers and specifications. Below is an order format that enables you to 'build your own switch' and specify the correct switch model number by simply selecting from all available options shown and filling in the boxes.

'BUILD YOUR OWN SWITCH' ORDER FORMAT

Fill in boxes with selections shown for **Model Structure**, then add **Options** selections for complete model number. Allowable options are shown below each respective box.

Example of completely specified model number:
B160R2NBB0BN

Series	Number of poles	Electrical functions	Terminals	Actuator type	Actuator marking
<input type="text" value="B"/>	<input type="text" value="1"/>	<input type="text" value="2"/>	<input type="text" value="0"/>	<input type="text" value="R"/>	<input type="text" value="2"/>
	1 Single pole	1 ON ON 2 ON OFF ON* 6 ON OFF *-Not available with double pole	Quick connect	Rocker	1 HI LO 2 No marking 3 ON OFF 4 O I 5 O —
Illumination	Case color	Actuator color	Lamp position	Terminal bending	Case marking
<input type="text" value="N"/>	<input type="text" value="A"/>	<input type="text" value="A"/>	<input type="text" value="0"/>	<input type="text" value="N"/>	<input type="text" value="N"/>
N No illum. L Illuminated Note: illumination available only with Green, Orange or Red Actuator colors.	A Gray B Black C Brown R Red W White	A Gray B Black C Brown G Green O Orange R Red W White Y Yellow	0 No lamp 1 Solder to term. 1 2 Solder to term. 2 Note 1 & 2 have neon lamp.	N No bending B Bend terms. 1 & 3	N No marking M "●" printing (consult factory)

QUICK-CONNECT TERMINAL

TERMINAL BENDING

PANEL CUT-OUTS

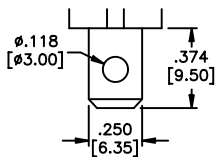

0

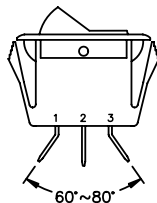

B

SINGLE POLE

pn.l. tk'nness.	A +0, -.004	B +0, -.004
.029-.049"	1.126"	.535"
.050-.078"	1.338"	.535"
.079-.118"	1.150"	.535"

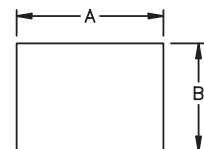

SPECIFICATIONS SUBJECT TO CHANGE WITHOUT NOTICE