

AKZ 1200

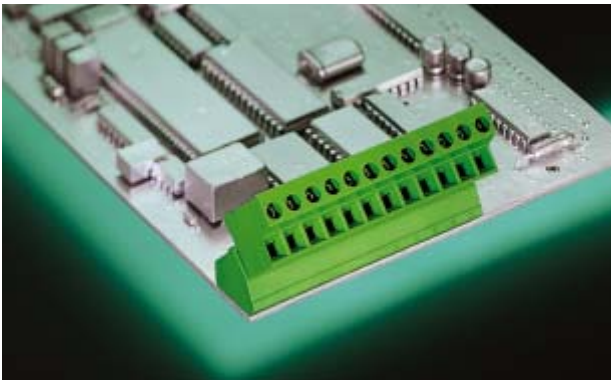

AKZ 1200/.. - 5,08 - green

**2-24 poles, Spacing 5,08 mm
insert required no. of poles ..**

How to order see page 11

AKZ 1200

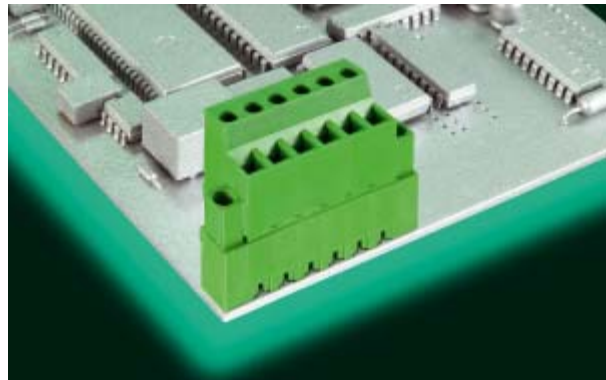



AKZ 1200/.. F - 5,08 - green

**2-20 poles, Spacing 5,08 mm
insert required no. of poles ..**

How to order see page 11

Ratings:

		
Rated Voltage	300 V	250 V
Rated Current	15 A	12 A (T60)
Oversoltage Category		III
Wire Size	AWG 22-12	2,5 mm ²
Rating Impulse Voltage/Dirt Level		4 kV/3
Rated Torque / Screw Size		0,5 Nm/M2,5

Max. Rated Cross Section

Single Wire (solid)	2,5 mm ²
Stranded Wire (flexible)	2,5 mm ²
Stranded wire with Ferrules	2,5 mm ²

Dimensions



Spacing	5,08 mm
Stripped Length	10,0 mm

Materials

Insulating Material	PA
Flammability Class	UL94 V-0
Temperature Range	-30°C/+105°C
Clamp cage	Fe/Fe
Contact	CuSn
Colour	green
	RAL 6018

Ratings:

*approval pending

		
Rated Voltage	300 V	250 V
Rated Current	15 A	12 A (T60)
Oversoltage Category		III
Wire Size	AWG 22-12	2,5 mm ²
Rating Impulse Voltage/Dirt Level		4 kV/3
Rated Torque / Screw Size		0,5 Nm/M2,5

Max. Rated Cross Section

Single Wire (solid)	2,5 mm ²
Stranded Wire (flexible)	2,5 mm ²
Stranded wire with Ferrules	2,5 mm ²

Dimensions

Spacing	5,08 mm
Stripped Length	10,0 mm

Materials

Insulating Material	PA
Flammability Class	UL94 V-0
Temperature Range	-30°C/+105°C
Terminal Block	Fe/Fe
Contact	CuSn
Colour	green
	RAL 6018

AKZ 1200

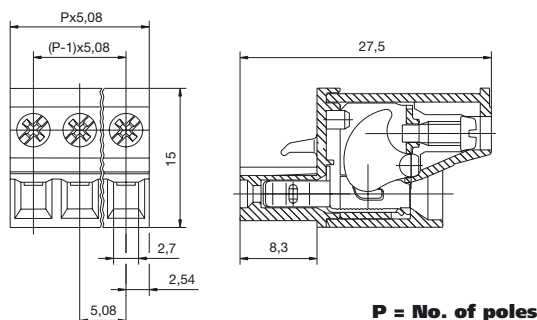

AKZ 1200 Flange

