

AKZ 1700

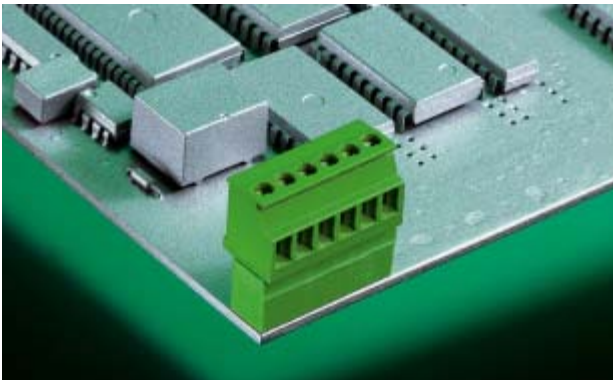

**AKZ 1700/.. - 3,81 - green**

**2-20 poles, Spacing 3,81 mm  
insert required no. of poles ..**

How to order see page 11

AKZ 1700

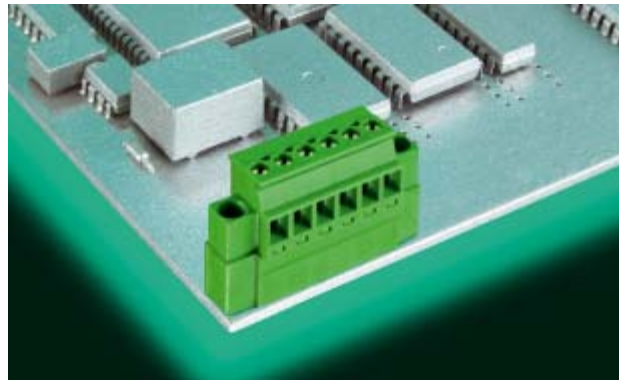



**AKZ 1700/.. F - 3,81 - green**

**2-20 poles, Spacing 3,81 mm  
insert required no. of poles ..**

How to order see page 11

**Ratings:**

		
Rated Voltage	300 V	160 V
Rated Current	8 A	9 A (T60)
Oversoltage Category		III
Wire Size	AWG 28-16	1,5 mm <sup>2</sup>
Rating Impulse Voltage / Dirt Level		2,5 kV/3
Rated Torque / Screw Size		0,4 Nm/M2

**Max. Rated Cross Section**

Single Wire (solid)	1,5 mm <sup>2</sup>
Stranded Wire (flexible)	1,0 mm <sup>2</sup>
Stranded wire with Ferrules	1,0 mm <sup>2</sup>

**Dimensions**



Spacing	3,81 mm
Stripped Length	7,0 mm

**Materials**

Insulating Material	PA
Flammability Class	UL94 V-0
Temperature Range	-30°C/+105°C
Terminal Block	CuZn
Contact	CuSn
Colour	green
	RAL 6018

**Ratings:**

\*approval pending

		
Rated Voltage	300 V	160 V
Rated Current	8 A	9 A (T60)
Oversoltage Category		III
Wire Size	AWG 28-16	1,5 mm <sup>2</sup>
Rating Impulse Voltage / Dirt Level		2,5 kV/3
Rated Torque / Screw Size		0,4 Nm/M2

**Max. Rated Cross Section**

Single Wire (solid)	1,5 mm <sup>2</sup>
Stranded Wire (flexible)	1,0 mm <sup>2</sup>
Stranded wire with Ferrules	1,0 mm <sup>2</sup>

**Dimensions**

Spacing	3,81 mm
Stripped Length	7,0 mm

**Materials**

Insulating Material	PA
Flammability Class	UL94 V-0
Temperature Range	-30°C/+105°C
Terminal Block	CuZn
Contact	CuSn
Colour	green
	RAL 6018

**AKZ 1700**

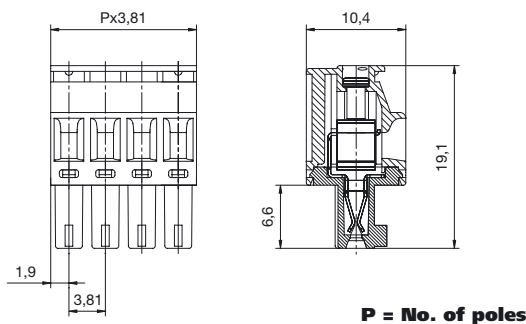

**AKZ 1700 Flange**

